

LFA

LIVE FREE ARMORY



AMP

USER / TECHNICAL MANUAL



WARNING!

Section 790.174, Florida Statutes, requires a loaded firearm in the home to be stored in a locked box container or secured with a trigger lock if the owner reasonably knows that a child under the age of 16 can gain access to the firearm. A violation of this law is a misdemeanor.

These simple steps may prevent needless and tragic injury or death so often associated with the careless storage and handling of firearms. Responsible and informed firearm owners use these storage and handling methods, without exception, to ensure the safety of those in the home.

- Never store or handle a loaded firearm in the home.
- Keep a trigger-locking device on the firearm, in addition to keeping it locked away, as an additional safety factor. There is no such thing as overemphasizing firearm safety.
- Lock firearms and ammunition in separate locations. This is a good backup precaution.
- Never point a firearm at anyone, loaded or unloaded. Too often the unintentional discharge of guns, even those believed to be unloaded, has killed or wounded innocent persons.
- Educate everyone in the home about firearms safety — especially children. Firearms are not toys. Emphasize the danger in, and outside, the home. Give reinforcement training frequently.

Firearm owners must always remember that a firearm may protect life, but it can also be a potential deadly threat to innocent persons. The proper storing and handling of a firearm must always be foremost in the mind of the owner who is responsible for the safety of those in the home.

5 RULES OF GUN SAFETY

- 1. TREAT ALL GUNS AS IF THEY'RE LOADED**
- 2. NEVER LET THE MUZZLE POINT AT ANYTHING YOU ARE NOT WILLING TO FIRE UPON.**
- 3. KEEP YOUR FINGER OFF THE TRIGGER UNTIL YOU ARE READY TO FIRE**
- 4. BE SURE OF YOUR TARGET AND WHAT'S BEHIND IT**
- 5. ALWAYS SECURE YOUR GUNS FROM UNAUTHORIZED PEOPLE**

STATE CONSTITUTIONAL PROVISION - ARTICLE 1, SECTION 8

- (A) THE RIGHT OF THE PEOPLE TO KEEP AND BEAR ARMS IN DEFENSE OF THEMSELVES AND OF THE LAWFUL AUTHORITY OF THE STATE SHALL NOT BE INFRINGED, EXCEPT THAT THE MANNER OF BEARING ARMS MAY BE REGULATED BY LAW.
- (B) THERE SHALL BE A MANDATORY PERIOD OF THREE DAYS, EXCLUDING WEEKENDS AND LEGAL HOLIDAYS, BETWEEN THE PURCHASE AND DELIVERY AT RETAIL OF ANY HANDGUN. FOR THE PURPOSES OF THIS SECTION, "PURCHASE" MEANS THE TRANSFER OF MONEY OR OTHER VALUABLE CONSIDERATION TO THE RETAILER, AND "HANDGUN" MEANS A FIREARM CAPABLE OF BEING CARRIED AND USED BY ONE HAND, SUCH AS A PISTOL OR REVOLVER. HOLDERS OF A CONCEALED WEAPON PERMIT AS PRESCRIBED IN FLORIDA LAW SHALL NOT BE SUBJECT TO THE PROVISIONS OF THIS PARAGRAPH.
- (C) ... ANYONE VIOLATING THE PROVISIONS OF SUBSECTION (B) SHALL BE GUILTY OF A FELONY. (D) THIS RESTRICTION SHALL NOT APPLY TO A TRADE IN OF ANOTHER HANDGUN." ARTICLE 1, SECTION 8.

THE LEGISLATURE OF THE STATE OF FLORIDA, IN A DECLARATION OF POLICY INCORPORATED IN ITS "WEAPONS AND FIREARMS" STATUTE, RECOGNIZES THAT ADULT CITIZENS OF THE STATE RETAIN THEIR CONSTITUTIONAL RIGHT TO KEEP AND BEAR FIREARMS FOR HUNTING AND SPORTING ACTIVITIES AND FOR DEFENSE OF SELF, FAMILY, HOME, AND BUSINESS AND AS COLLECTIBLES.

TABLE OF CONTENTS

DESCRIPTION	5
MAIN COMPONENTS.....	6
PARTS DIAGRAM	7
SLIDE PARTS DIAGRAM	7
GRIP MODULE PARTS DIAGRAM.....	8
CABLE LOCK	9
AMMUNITION.....	10
HANDLING.....	13
LOADING THE FIREARM	14
FIRING THE PISTOL.....	15
RELOADING DURING SHOOTING	16
CLEARING A STOPPAGE	17
UNLOADING THE PISTOL	18
MAINTENANCE	19
FIELD STRIPPING PISTOL	19
CLEANING THE AMP	21
FUNCTION VERIFICATION.....	24
SPECIFICATIONS	25
WARRANTY.....	26
MAINTENANCE SCHEDULE	27
STATE SAFETY WARNINGS.....	28

DESCRIPTION OF FIREARM

GENERAL

The AMP is the perfect blend of precision and feel of a traditional steel pistol without compromising the reliability and comfort of a modern polymer handgun. This Aluminum Match-Grade Pistol was designed by a team of engineers, competitive shooters, and law enforcement with the purpose of developing the ultimate mission ready pistol that they would depend their own life on. The Fire Control Unit is precision CNC machined out of heat treated 17-4 Steel. This design allows for the rails to be machined perfectly flat to each other and held to a .0005 specification to reduce any unnecessary play seen in many traditional firearms. The AMP's aluminum milled grip module reduces flex and recoil while shooting. The skeletonized 1911-angled grip module allows for custom and aftermarket grip panels to modify for an intuitive and reliable feel. The grip module features an extended beavertail that allows the pistol to sit lower and more comfortably in the shooter's hand for better recoil control and improved accuracy. The trigger, barrel, slide, sights, and most internals are Glock® compatible. The AMP slide is machined with stepped quad windows and deeper serrations on the slide to enhance grip, reduce weight, and improve cycling speed. The slide comes standard with an RMR optic cut to directly mount a sight without cumbersome plates or adapters. The match-grade nitrided fluted barrel is honed, burnished to an 8-micron finish, and rifle cut for unparalleled accuracy. Whether it be giving you the next competitive edge on the field or the security you need for home defense. The AMP (Aluminum Match-Grade Pistol) is ready for any mission.z

FEATURES

- Striker-fired design pistol
- Picatinny Rail built into the grip module. Sized to easily fit industry standard tactical accessories
- Full aluminum grip module to maintain strength and stability
- Modular design allows to easily interchange parts to fit the user's preferences
- Easy to swap grip panels to change the handgun to a user's preference and the environment
- 1911 grip angle
- Utilizes Glock® 19 slides and magazines

MAIN COMPONENTS

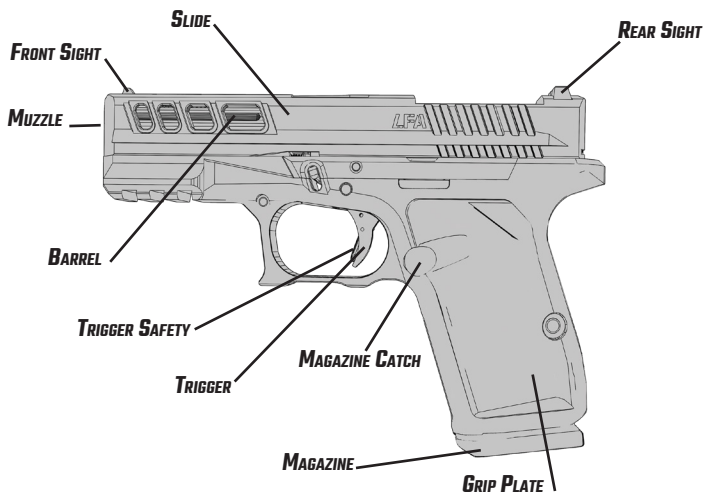

PARTS DIAGRAM

SLIDE PARTS DIAGRAM

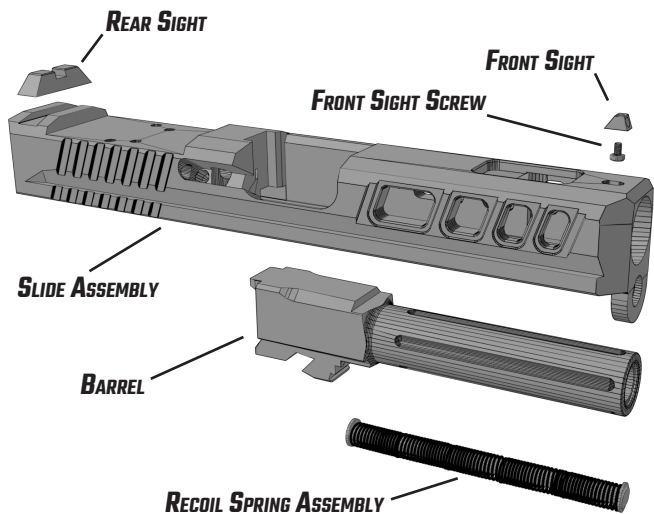

PARTS DIAGRAM

GRIP MODULE PARTS DIAGRAM

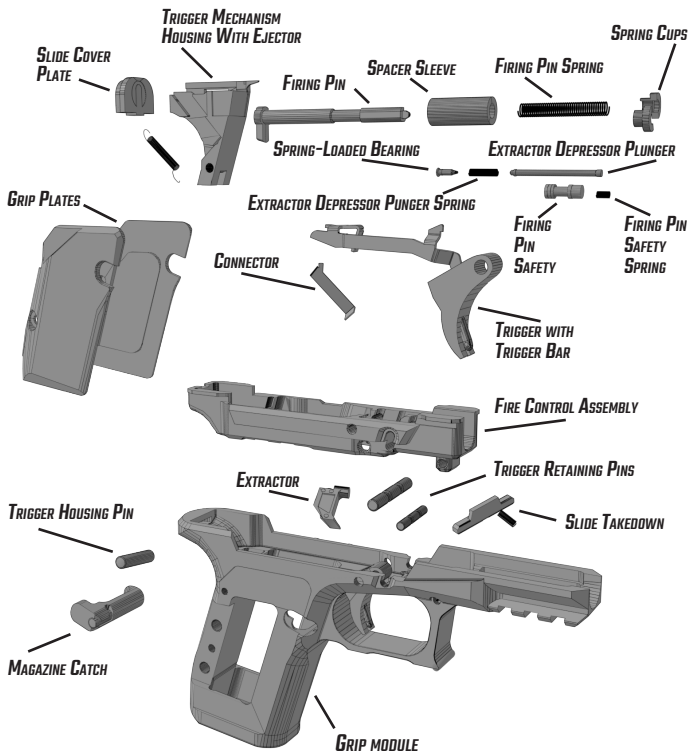

CABLE LOCK

The AMP comes with a standard cable lock. The cable is installed in unloaded pistols. Store your pistol with the lock installed.

1. Pull the slide.
2. Lock the slide open in the rearward position.
3. Insert the end of the cable through the ejection port and through the magwell.
4. Insert the end of the cable into lock.
5. Turn key and remove.
6. Tug on lock to ensure functionality.



AMMUNITION

The correct caliber of the AMP is engraved on the firearm barrel. Do not use ammunition of a different caliber with your firearm. Only use ammunition of the caliber for which your firearm is chambered.

Do not use cartridges that are dirty, wet, corroded, bent, or damaged.

Do not oil, spray aerosol-type lubricants, preservatives, or cleaners directly onto cartridges.

Using reloaded, "remanufactured" hand-loaded, or other non-standard ammunition voids all warranties. Severe injury may result to the shooter or damage the firearm. Always use ammunition that complies with the industry performance standards established by the Sporting Arms and Ammunition Manufacturers' Institute, Inc. (SAAMI) or ammunition manufactured to military specifications.

WARNING – AMMUNITION (CARTRIDGE) NOTICE

LIVE FREE ARMORY SPECIFICALLY DISCLAIMS RESPONSIBILITY FOR ANY DAMAGE OR INJURY WHATSOEVER OCCURRING IN CONNECTION WITH, OR AS A RESULT OF, THE USE IN ANY LIVE FREE ARMORY FIREARM OF NON-STANDARD, RELOADED, "REMANUFACTURED" HAND-LOADED, OR FAULTY AMMUNITION, OR CARTRIDGES OTHER THAN THOSE FOR WHICH THE FIREARM WAS ORIGINALLY CHAMBERED.

Serious injury to the shooter or to others, or severe damage to the firearm may result from any condition causing excessive pressure inside the chamber or barrel during firing.

Excessive pressure can happen by the following but not limited to:

- barrel obstructions
- propellant powder overloads
- the use of incorrect, damaged or defectively assembled cartridges

The use of a dirty, corroded, or damaged cartridge can lead to a burst cartridge case and consequent damage to the firearm and personal injury from the sudden escape of high-pressure propellant gas within the firearm's mechanism.

IF THERE IS ANY REASON TO SUSPECT OF A BARREL OBSTRUCTION, IMMEDIATELY UNLOAD THE FIREARM AND THOROUGHLY INSPECT THE BORE AND BARREL. IT IS NOT SUFFICIENT TO ONLY LOOK IN THE CHAMBER.

Immediately stop shooting and check the barrel for a possible obstruction whenever, but not limited to:

- You have difficulty in, or feel unusual resistance in, chambering a cartridge
- A cartridge misfires (does not go off)
- The mechanism fails to extract a fired cartridge case
- Unburned grains of propellant powder are discovered spilled in the mechanism
- A shot sounds weak or abnormal. In such cases it is possible that a bullet is lodged partway down the barrel. Firing a subsequent bullet into the obstructed barrel can damage the firearm and cause serious injury to the shooter or to bystanders

Bullets can become lodged in the barrel if, but not limited to:

- The cartridge may have been improperly loaded, or the powder may have failed to ignite properly.
- The bullet may not have been properly seated in the cartridge case.

A bullet may be lodged at anywhere in the barrel. It may not be easily seen without a thorough inspection of the barrel.

WARNING – LODGED BULLET

NEVER SHOOT OUT ANY FORM OF BORE OR BARREL OBSTRUCTION (BULLET OR OTHERWISE) BY USING ANOTHER CARTRIDGE OR BY A BLANK OR ONE FROM WHICH THE BULLET HAS BEEN REMOVED. DOING SO CAN GENERATE EXCESSIVE PRESSURE, DAMAGE THE FIREARM, AND CAUSE SERIOUS PERSONAL INJURY.

If the bullet can be removed with a cleaning rod, clean any unburned powder grains from the bore, chamber, and mechanism before resuming shooting. If the bullet cannot be dislodged by tapping it with a cleaning rod, send the firearm to Live Free Armory.

Dirt, corrosion, or other foreign matter on a cartridge can impede complete chambering and may cause the cartridge case to burst upon firing. The same is true of cartridges that are damaged or deformed.

Do not oil cartridges, and be sure to wipe the chamber clean of any oil or preservative before commencing to shoot. Oil interferes with the friction between cartridge case and chamber wall that is necessary for safe functioning, and subjects the firearm to stress similar to that imposed by excessive pressure.

Use lubricants sparingly on the moving parts of your firearm. Avoid excessive spraying of any aerosol gun care product, especially where it may get on ammunition. All lubricants and aerosol spray lubricants, in particular, can penetrate cartridge primers and cause misfires. Some highly penetrative lubricants can also migrate inside cartridge cases and cause deterioration of the propellant powder; on firing, the powder may not ignite. If only the primer ignites, there is danger that the bullet may become lodged in the barrel.

WARNING – AMMUNITION

DEATH, SERIOUS INJURY, AND DAMAGE CAN RESULT FROM THE USE OF WRONG AMMUNITION, BORE OBSTRUCTIONS, POWDER OVERLOADS, OR INCORRECT CARTRIDGE COMPONENTS. ALWAYS WEAR SHOOTING GLASSES AND HEARING PROTECTORS.

IMPROPER AMMUNITION DESTROYS FIREARMS

WARNING – LEAD EXPOSURE

DISCHARGING FIREARMS IN POORLY VENTILATED AREAS, CLEANING FIREARMS, OR HANDLING AMMUNITION MAY RESULT IN EXPOSURE TO LEAD AND OTHER SUBSTANCES KNOWN TO THE STATE OF CALIFORNIA TO CAUSE BIRTH DEFECTS, REPRODUCTIVE HARM, AND OTHER SERIOUS PHYSICAL INJURY. MAINTAIN ADEQUATE VENTILATION AT ALL TIMES.

WASH HANDS THOROUGHLY AFTER EXPOSURE.

SHOOTING OR CLEANING FIREARMS MAY EXPOSE YOU TO LEAD

HANDLING

PREPARATION INSTRUCTIONS

We strongly suggest you perform an initial cleaning and lubrication of the pistol once it is unpacked. Any fouling present will have been from final range firing at the factory prior to shipping. Please refer to this manual's section for instructions pertaining to cleaning the pistol. If you have the pistol and ammunition, and have read and understood all of the safety instructions, you are now ready to use the pistol.

WARNING - YOUR AMP PISTOL DOES NOT HAVE A STANDARD MANUAL SAFETY.

IT WILL FIRE IF THERE IS A ROUND IN THE CHAMBER AND THE TRIGGER IS PULLED.

WARNING - ALWAYS BE SURE THAT THE BARREL IS CLEAR OF ANY OBSTRUCTIONS.

REMOVE ANY OBSTRUCTIONS BEFORE FIRING YOUR PISTOL SO THAT IT WILL FUNCTION SAFELY AND CORRECTLY. OBSTRUCTIONS IN THE BARREL COULD PREVENT THE PISTOL FROM FIRING PROPERLY AND RESULT IN DEATH OR SERIOUS PERSONAL INJURY OR DAMAGE TO THE PISTOL.

WARNING - ALWAYS WEAR PERSONAL PROTECTION EQUIPMENT WHEN USING YOUR AMP

ALWAYS WEAR EYE AND HEARING PROTECTION WHEN FIRING YOUR PISTOL.

WARNING - KEEP THE EJECTION PORT CLEAR

NEVER BLOCK THE EJECTION. BLOCKING THE EJECTION PORT DURING FIRING COULD CAUSE MALFUNCTIONS, RESULT IN DEATH OR SERIOUS PERSONAL INJURY OR DAMAGE TO THE PISTOL.

WARNING - KEEP PATH OF EXPELLING CASINGS FROM THE EJECTION PORT CLEAR

EMPTY BULLET CASINGS ARE HOT AND MOVE AT HIGH SPEEDS FROM THE EJECTION PORT. DO NOT FIRE IF ANY PART OF YOUR BODY OR ANYONE ELSE IS WITHIN THE PATH OF EXPELLING CASINGS. NEVER ALLOW ANYONE TO STAND BESIDE YOU WHERE THEY MAY BE STRUCK BY A BULLET CASING.

LOADING THE FIREARM

The LFA AMP takes standard OEM Glock® 19 & PMAG® Glock® 19 magazines. Ensure you are using the proper and undamaged magazine to the firearm and caliber.

LOADING THE PISTOL (READY TO FIRE)

1. Point the pistol in a safe direction.
2. Retract the slide and lock it to the rear by pushing up on slide catch lever.
3. Inspect the chamber to ensure it is clear.
4. Inspect breech face and magazine well for any foreign debris.
5. Push a loaded magazine up into the grip module until it locks in place. There should be an audible click when the magazine is properly loaded and ready.
6. Release the slide by either:
 - a. Pressing down on the slide catch lever releasing the slide forward, chambering a cartridge.
 - b. Slightly pull back on the slide and release it to chamber a cartridge.



WARNING – LOADED PISTOL

THE PISTOL IS NOW LOADED AND READY TO FIRE

FIRING THE PISTOL

1. Aim the pistol at a safe target.
2. Place finger on the trigger only when ready to fire.
3. Depress trigger to discharge.
4. Keep pistol aimed at the target and continue to fire as required or until the magazine is empty.
5. Remove the magazine, unload and clear the pistol. If the pistol is fired until the magazine is empty, the slide will remain locked to the rear. Reload the pistol to continue firing.
6. Press magazine catch to remove the magazine, unload.



RELOADING DURING SHOOTING

The slide will lock back in the open position after the last round is fired by the slide catch lever automatically.

1. Press the magazine catch.
2. Remove the empty magazine.
3. Insert a loaded magazine (ensure it is fully in place after an audible click).
4. Release the slide by either:
 - a. Pressing down on the slide catch lever
 - b. Pulling back on the slide and release

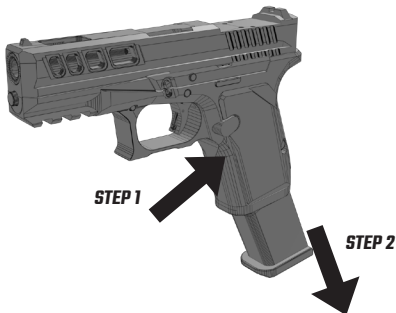

STEP 3

WARNING – LOADED PISTOL

THE PISTOL IS NOW LOADED AND READY TO FIRE

WARNING – LOADED PISTOL

THE PISTOL IS NOW LOADED AND READY TO FIRE.

ENSURE THE MUZZLE IS POINTED IN A SAFE DIRECTION! DO NOT PLACE YOUR FINGER ON THE TRIGGER UNTIL YOU ARE READY TO FIRE THE PISTOL.

NEVER FIRE ANY FIREARM WITH ANY PART OF YOUR BODY OVER OR NEAR THE EJECTION PORT.

CLEARING A STOPPAGE

An unfired cartridge or fired cartridge case may occasionally become jammed between the slide and the barrel. WHILE KEEPING THE MUZZLE POINTED IN A SAFE DIRECTION, clear the stoppage as follows:

1. Press magazine catch and remove magazine.
2. Pull back slide and lock it to the rear by pushing up on the slide catch lever.
3. Dislodge any expended casings or live cartridges from pistol.
4. Visually and physically inspect chamber and breech face to make sure pistol is cleared.

WARNING – EJECTION

THE SLIDE OPENS AND SHUTS QUICKLY WHILE FIRING. KEEP FACE AND HANDS AWAY FROM IT. HOT BRASS AND POWDER GAS IS EJECTED QUICKLY AND CAN BURN YOU. ALWAYS WEAR SAFETY GLASSES AND HEARING PROTECTION.

UNLOADING THE PISTOL

WARNING – UNLOADING

REMOVING CARTRIDGES FROM THE MAGAZINE DOES NOT PREVENT THE PISTOL FROM BEING FIRED! WHEN THERE IS A CARTRIDGE IN THE CHAMBER, THE CARTRIDGE WILL DISCHARGE IF THE TRIGGER IS PRESSED.

IT IS ABSOLUTELY ESSENTIAL FOR THE USER TO KNOW HOW TO COMPLETELY UNLOAD THE PISTOL.

“COMPLETELY” MEANS EMPTYING THE MAGAZINE AND REMOVING A CHAMBERED CARTRIDGE.

PISTOL WILL FIRE WITH MAGAZINE EMPTY OR REMOVED

UNLOADING THE PISTOL (MAGAZINE NOT EMPTY)

1. Keep the muzzle pointed in a safe direction and engage manual safety if so equipped.
2. Press the magazine catch and remove the magazine.
3. Pull the slide completely to the rear while watching for ejection of live cartridge. Push up on slide catch lever locking slide open.
4. Visually and physically check the chamber to ensure the pistol is completely free of ammunition from the chamber end.
5. Depress the slide catch lever, causing the slide to close.
6. Unload the magazine.

UNLOADING THE PISTOL (MAGAZINE EMPTY, SLIDE OPEN)

1. Keep the muzzle pointed in a safe direction and engage manual safety if so equipped.
2. Depress the magazine catch and remove the magazine.
3. Visually and physically check the chamber to ensure the pistol is completely free of ammunition from the chamber end.
4. Depress the slide catch lever, causing the slide to close.

Always make sure the muzzle is pointed in a safe direction! Remember to clear the chamber after the magazine has been removed.

Never assume that any firearm is unloaded until you have personally checked it, visually and physically!

After every range session, make a final check to be certain the firearm is unloaded before leaving the range.

MAINTENANCE

WARNING – VERIFY THE MAGAZINE IS REMOVED AND THERE ARE NO ROUNDS IN THE CHAMBER

VISUALLY AND PHYSICALLY CONFIRM THE PISTOL IS UNLOADED AND CLEARED BEFORE ATTEMPTING DISASSEMBLY OR PERFORMING ANY MAINTENANCE STEPS. FAILURE TO ENSURE THE FIREARM IS UNLOADED AND CLEARED COULD RESULT IN UNINTENTIONAL DISCHARGE, CAUSING SEVERE INJURY OR DEATH, OR PROPERTY DAMAGE.

VERIFY THE FIREARM IS UNLOADED AND CLEARED

FIELD STRIPPING PISTOL

1. Unload the pistol by removing the magazine and retract slide to eject a chambered round and to inspect there is no round in the chamber. Do not proceed until the firearm is unloaded and cleared (refer to Unloading the Pistol for more information on page 18).
2. Point your pistol in a safe direction where no one can possibly be injured in the event of an unintentional discharge, pull the trigger. The trigger must be in the rearmost position to remove the slide.
3. Hold your AMP pistol with your firing hand, fingers reaching around the top of the rear of the slide in front of the rear sight and your thumb on the rear of the grip module.
4. With your fingers, retract the slide about 1/8 in. / 3mm and hold it in this position. Do not pull too far. Pulling the slide too far will reset the trigger to the forward position. If this happens, point your pistol in a safe direction where no one can possibly be injured in the event of an unintentional discharge, pull the trigger.
5. Using the thumb and index finger of your other hand, pull the slide lock down on both sides.
6. While holding the slide lock down, push the slide forward and off of the grip module.
7. Press the recoil spring assembly toward the front while pulling it up to remove it from the slide.
8. Holding the barrel by the barrel locking cams, lift it and push it toward the front of the slide and then pull it up and toward the rear to remove it from the slide.

FIELD STRIPPING PISTOL (CONT.)

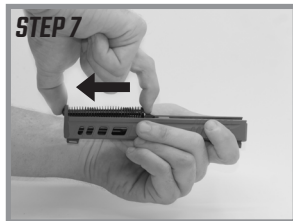
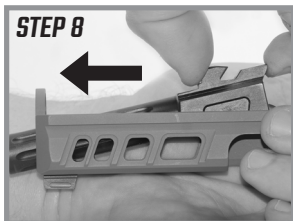

CLEANING THE AMP PISTOL

WARNING – CLEANING

NEVER CLEAN THE BARREL FROM THE MUZZLE END; DO NOT USE A STEEL WIRE BRUSH AS IT CAN DAMAGE THE SMOOTH SURFACE OF THE BARREL. USE A SUITABLE CLEANING ROD AND A BRONZE BRUSH OF THE CORRECT CALIBER. SOLVENTS CAN BE HARMFUL TO THE SURFACE FINISH OF THE PISTOL. READ AND FOLLOW THE MANUFACTURER'S WARNINGS BEFORE USING SOLVENTS OR CLEANERS. WEAR EYE PROTECTION.

AVOID OVER-LUBRICATION OF COMPONENTS.

WARNING – LUBRICATION

DO NOT LUBRICATE THE STRIKER OR ALLOW LUBRICANT TO FLOW INTO THE STRIKER CHANNEL OF THE SLIDE. THIS MAY CAUSE A LIGHT STRIKE TO THE CARTRIDGE RESULTING IN A FAILURE TO FIRE.

The following instructions are for normal environmental conditions. Clean and lube before or after every day the pistol is fired and at a minimum of every 500 rounds.

BARREL

1. Wet a cleaning patch with lubricant and push it through the bore from the chamber end and out past the muzzle with a cleaning rod.
2. Wipe the exterior of the barrel with a cloth soaked in lubricant.
3. Repeat step #1.
4. Use the bore brush and a cleaning rod to scrub heavy deposits from the bore.
5. Repeat step #1.
6. Push dry patches through the bore until they come out clean.
7. Always remove any lubricant from the bore prior to firing the pistol.

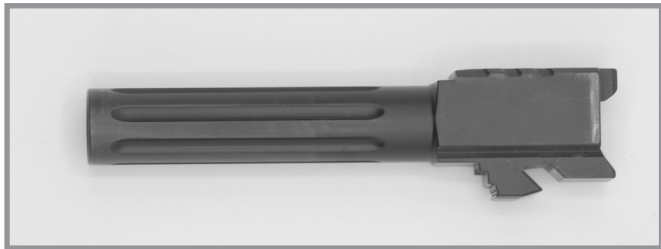

RECOIL SPRING AND GUIDE ASSEMBLY

The AMP recoil spring and guide assembly is not to be disassembled.

1. Clean the recoil spring guide assembly with lubricant and a soft brush.
2. After cleaning, apply a light coat of lubricant.

GRIP MODULE ASSEMBLY

1. Wipe the grip module assembly with a soft cloth.
2. Use cotton swabs to clean hard to reach areas. Pay special attention to the grip module rails, takedown lever and slide catch lever.
3. Lubricate the grip module rails with a light coat of lubricant.
4. Apply lubricant to accessible functioning parts.
5. Clean the magazine well of any dirt, dust or residue with a soft cloth.

SLIDE

1. Wet a nylon bristle brush with lubricant and thoroughly brush the rail cuts in the slide where it meets the slide rails on the grip module
2. Wipe the rail cuts in the slide with a clean patch and examine it. If it is not clean, repeat steps 1 and 2 until the patch remains clean.
3. Wet a nylon bristle brush with lubricant and, while holding the slide with the muzzle end facing down, brush the breech face and the area under the extractor claw.
4. While holding the slide with the muzzle end facing down, wipe the breech face and the area under the extractor claw with a clean patch.
5. Check all other exposed areas of the slide for cleanliness. If any dirt or debris is found, remove it with lubricant using a nylon bristle brush, patch, or a clean, soft cloth.
6. Wipe the exposed areas of the slide that you have cleaned in step 5 with a clean patch and examine it. If it is not clean, repeat steps 5 and 6 until the patch remains clean.

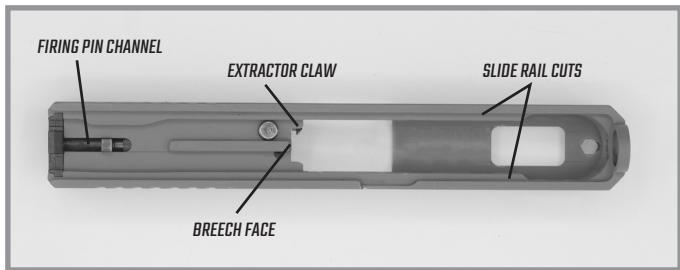

LUBRICATE PISTOL

After you have clean your AMP, lubricate the following parts:

1. Slightly dampen a clean cloth with gun oil or lubricant and wipe the outside of the barrel.
2. Place a drop of gun oil or lubricant where the rear end of the trigger bar touches the connector at the right rear corner of the grip module.
3. Spread a drop of gun oil or lubricant along the slide rail.
4. Wipe down the exterior surface of slide with a slightly dampened clean cloth with gun oil or lubricant.

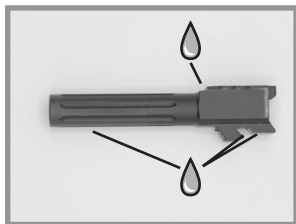

PISTOL REASSEMBLY

1. Holding the barrel by the barrel locking cams, insert it into the slide by pushing it down and in..
2. Place the small end of the recoil spring assembly in the hole underneath the muzzle hole in the front of the slide.
3. Compress the spring and push down until the large end of the recoil spring assembly rests in the second notch on the barrel locking cams.
4. Place the slide on top of the grip module in front of the slide rails and push the slide towards the back of the grip module until the slide lock snaps up to lock the slide into place.

FUNCTION VERIFICATION

The function check is performed on the assembled pistol to verify functionality. It should be performed after the completion of repairs and after each cleaning and assembly of the pistol.

WARNING – MAINTENANCE

Verify the magazine is removed – visually and physically confirm the pistol is unloaded and cleared before disassembly or performing any maintenance. Failure to ensure the firearm is unloaded and cleared could result in unintentional discharge, causing severe injury or death, or property damage.

VERIFY THE FIREARM IS UNLOADED AND CLEARED

1. Ensure the magazine is removed and the pistol is unloaded and cleared
2. Check recoil spring function/slide travel.
 - a. Retract the slide fully and release.
 - b. Verify the slide locks fully in the closed position.
 - c. Repeat the procedure.
3. Check the trigger mechanism:
 - a. Press the trigger fully to the rear.
 - b. As the trigger is pressed rearward the striker is released causing an audible click.
4. Check slide catch lever.
 - a. Insert an empty magazine.
 - b. Retract the slide fully and release.
 - c. Verify the slide is locked to the rear by the slide catch lever.
 - d. Depress the slide catch lever.
 - e. Verify the slide is released and closes in the locked position.
 - f. Remove the magazine.
5. Inspect the magazine.
 - a. Check the condition of the magazine tube.
 - b. Verify the magazine floorplate is secure.
 - c. Check for free movement of the magazine follower and spring.
 - d. Insert the magazine into the pistol and remove. Verify smooth insertion. Check the magazine catch for clean engagement and smooth release.
6. Inspect the pistol exterior.
 - a. Inspect the general condition of the pistol.
 - b. Check the sights, grip module, slide, and takedown lever for damage.
 - c. Verify the front and rear sights are secure.

AMP COMPACT SPECIFICATIONS

Caliber	9x19
Height Including Magazine	5.2 inches
Slide Width	1.002 inches
Width (Overall)	1.275 inches
Slide Length Complete	6.74 inches
Length (Overall)	7.1 inches
Weight Loaded	2.1 lbs
Weight Including Magazine	1.7 lbs
Magazine Capacity	15
Barrel Length	3.925 inches
Barrel Rifling	6gmm 1:10 twist
Length of Twist	250 9.84 inches
Trigger Pull	6.8 lbs
Trigger Travel	0.45 inches
Sight Radius	6.06 inches

LIVE FREE ARMORY® LIMITED LIFETIME FIREARMS WARRANTY

Live Free Armory will warranty factory-built firearms against defects in material or workmanship for the lifetime of the product. Live Free Armory agrees to correct any defect in a firearm by repair or replacement with the same or comparable quality components at Live Free Armory's discretion, provided that the firearm is returned unloaded and freight prepaid to Live Free Armory at:

***680 N JOHN RODES BLVD. BUILDING D,
MELBOURNE, FLORIDA 32934***

This warranty is null and void if the firearm has been misused, damaged, or fired with hand loaded, reloaded or improper ammunition that does not correlate with SAAMI specifications. Failure to perform reasonable and necessary maintenance as described in the manual will void the warranty. Firing the rifle with an obstruction in the barrel will void the warranty. Any repairs or modifications to the firearm (including cosmetic), if not performed by Live Free Armory, will void the warranty. Any modifications to the barrel will void the warranty. This warranty does not apply to normal wear and tear, and does not apply to any accessory items attached to the firearm. Live Free Armory does supply components of firearms, which may result in complete firearms that were not factory built by Live Free Armory. If you are uncertain whether your firearm was factory built by Live Free Armory, please contact us at 407-891-1255 to verify the status, using the serial number.

MAINTENANCE SCHEDULE

To ensure a long lasting firearm, Live Free Armory recommends the following schedule of maintenance and replacement of parts.

CLEANING AND LUBING

Every 500 and after every shooting

RECOIL SPRING

Replace every 2,500 rounds

EXTRACTOR DEPRESSOR PLUNGER SPRING

Replace every 5,000 rounds

FIRING PIN

Replace every 5,000 rounds

FIRING PIN SPRING

Replace every 15,000 rounds

FIRING PIN SAFETY SPRING

Replace every 15,000 rounds

FIRING PIN SPRING

Replace every 15,000 rounds

MAGAZINE CATCH SPRING

Replace every 15,000 rounds

STANDARD TRIGGER SPRING

Replace every 15,000 rounds

SLIDE LOCK SPRING

Replace every 15,000 rounds

SLIDE STOP LEVER SPRING

Replace every 15,000 rounds

To purchase replacement parts, please contact sales@LiveFreeArmory.com

STATE REQUIRED SAFETY WARNINGS

California:

WARNING!

"Firearms must be handled responsibly and securely stored to prevent access by children and other unauthorized users. California has strict laws pertaining to firearms, and you may be fined or imprisoned if you fail to comply with them. Visit the Web site of the California Attorney General at <https://oag.ca.gov/firearms> for information on firearm laws applicable to you and how you can comply. Prevent child access by always keeping guns locked away and unloaded when not in use. If you keep a loaded firearm where a child obtains and improperly uses it, you may be fined or sent to prison."

Connecticut:

"UNLAWFUL STORAGE OF A LOADED FIREARM MAY RESULT IN IMPRISONMENT OR FINE."

Florida:

"IT IS UNLAWFUL, AND PUNISHABLE BY IMPRISONMENT AND FINE, FOR ANY ADULT TO STORE OR LEAVE A FIREARM IN ANY PLACE WITHIN THE REACH OR EASY ACCESS OF A MINOR UNDER 18 YEARS OF AGE OR TO KNOWINGLY SELL OR OTHERWISE TRANSFER OWNERSHIP OR POSSESSION OF A FIREARM TO A MINOR OR A PERSON OF UNSOUND MIND."

Maine:

"ENDANGERING THE WELFARE OF A CHILD IS A CRIME. IF YOU LEAVE A FIREARM AND AMMUNITION WITHIN EASY ACCESS OF A CHILD, YOU MAY BE SUBJECT TO FINE, IMPRISONMENT OR BOTH. KEEP FIREARMS AND AMMUNITION LOCKED UP. USE TRIGGER LOCKS."

Maryland:

WARNING: "CHILDREN CAN OPERATE FIREARMS WHICH MAY CAUSE DEATH OR SERIOUS INJURY. IT IS A CRIME TO STORE OR LEAVE A LOADED FIREARM IN ANY LOCATION WHERE AN INDIVIDUAL KNEW OR SHOULD HAVE KNOWN THAT AN UNSUPERVISED MINOR WOULD GAIN ACCESS TO THE FIREARM. STORE YOUR FIREARM RESPONSIBLY!"

Massachusetts:

"WARNING FROM THE MASSACHUSETTS ATTORNEY GENERAL: This handgun is not equipped with a device that fully blocks use by unauthorized users. More than 200,000 firearms like this one are stolen from their owners every year in the United States. In addition, there are more than a thousand suicides each year by younger children and teenagers who get access to firearms. Hundreds more die from accidental discharge. It is likely that many more children sustain serious wounds, or inflict such wounds accidentally on others. In order to limit the chance of such misuse, it is imperative that you keep this weapon locked in a secure place and take reasonable preventive steps necessary to limit the possibility of theft or accident. Failure to take reasonable preventative steps may result in innocent lives being lost, and in some circumstances may result in your liability for these deaths."

CONTINUED ON NEXT PAGE

"IT IS UNLAWFUL TO STORE OR KEEP A FIREARM, RIFLE, SHOTGUN OR MACHINE GUN IN ANY PLACE UNLESS THAT WEAPON IS EQUIPPED WITH A TAMPER-RESISTANT SAFETY DEVICE OR IS STORED OR KEPT IN A SECURELY LOCKED CONTAINER."

New Jersey:

"IT IS A CRIMINAL OFFENSE TO LEAVE A LOADED FIREARM WITHIN EASY ACCESS OF A MINOR."

New York City:

"THE USE OF A LOCKING DEVICE OR SAFETY LOCK IS ONLY ONE ASPECT OF RESPONSIBLE FIREARMS STORAGE. FOR INCREASED SAFETY, FIREARMS SHOULD BE STORED UNLOADED AND LOCKED IN A LOCATION THAT IS BOTH SEPARATE FROM THEIR AMMUNITION AND INACCESSIBLE TO CHILDREN AND OTHER UNAUTHORIZED PERSONS."

North Carolina:

"IT IS UNLAWFUL TO STORE OR LEAVE A FIREARM THAT CAN BE DISCHARGED IN A MANNER THAT A REASONABLE PERSON SHOULD KNOW IS ACCESSIBLE TO A MINOR."

Texas:

"IT IS UNLAWFUL TO STORE, TRANSPORT, OR ABANDON AN UNSECURED FIREARM IN A PLACE WHERE CHILDREN ARE LIKELY TO BE AND CAN OBTAIN ACCESS TO THE FIREARM."

Wisconsin:

"IF YOU LEAVE A LOADED FIREARM WITHIN THE REACH OR EASY ACCESS OF A CHILD YOU MAY BE FINED OR IMPRISONED OR BOTH IF THE CHILD IMPROPERLY DISCHARGES, POSSESSES, OR EXHIBITS THE FIREARM." State laws and regulations concerning firearms change constantly. Please check with your local federally licensed firearm dealer or state police for additional laws and regulations regarding the storage and use of firearms in your state.

THIS LIST IS ONLY A BRIEF GUIDE. LAWS AND REGULATIONS CHANGE DAILY. THE OWNER IS RESPONSIBLE FOR KNOWING THEIR OWN STATE LAWS. LIVE FREE ARMORY IS NOT RESPONSIBLE FOR ANY CRIMES OR MISUSE OF THIS FIREARM.



WWW.LIVEFREEARMORY.COM

**FOR PRODUCT SERVICE ON THIS MODEL,
PLEASE CALL (407) 891-1255**

**PLANT 1
680 N JOHN RODES BLVD. BUILDING D, MELBOURNE,
FLORIDA 32934 USA**

**PLANT 2
4324 FORTUNE PLACE
WEST MELBOURNE, FL 32904**